

V_{RRM}	=	1200 V
$I_F (T_c=154\text{ }^\circ\text{C})$	=	20 A
Q_C	=	126 nC



TO-220-2

Features

- 1.2kV Schottky Rectifier
- Zero Reverse Recovery Current
- High-Frequency Operation
- Temperature-Independent Switching
- Extremely Fast Switching

Benefits

- Replace Bipolar with Unipolar Rectifiers
- Essentially No Switching Losses
- High Efficiency
- Reduction of Heat Sink Requirements
- Parallel Devices Without Thermal Runaway

Applications

- Switching Mode Power Supply
- Boost Diodes in PFC
- DC/DC Converters
- AC/DC Converters
- Free Wheeling Diodes in Inverter

Maximum Ratings ($T_c = 25\text{ }^\circ\text{C}$ unless otherwise specified)

Symbol	Parameter	Value	Unit	Test Conditions	Note
V_{RRM}	Repetitive Peak Reverse Voltage	1200	V		
V_{RSM}	Surge Peak Reverse Voltage	1300	V		
V_R	DC Peak Reverse Voltage	1200	V		
I_F	Continuous Forward Current	69 32 20	A	$T_c=25\text{ }^\circ\text{C}$ $T_c=135\text{ }^\circ\text{C}$ $T_c=154\text{ }^\circ\text{C}$	Fig. 3
I_{FSM}	Non-Repetitive Forward Surge Current	160	A	$T_c=25\text{ }^\circ\text{C}$, $t_p=10\text{ ms}$, Half Sine Pulse	
P_{tot}	Power Dissipation	333 144	W	$T_c=25\text{ }^\circ\text{C}$ $T_c=110\text{ }^\circ\text{C}$	Fig. 4
T_J	Operating Junction Range	-55 to +175	$^\circ\text{C}$		
T_{stg}	Storage Temperature Range	-55 to +175	$^\circ\text{C}$		

Electrical Characteristics

Symbol	Parameter	Typ.	Max.	Unit	Test Conditions	Note
V_F	Forward Voltage	1.45 2.2	1.75 2.6	V	$I_F = 20\text{ A}, T_J = 25\text{ }^\circ\text{C}$ $I_F = 20\text{ A}, T_J = 175\text{ }^\circ\text{C}$	Fig. 1
I_R	Reverse Current	15 50	200 500	μA	$V_R = 1200\text{ V}, T_J = 25\text{ }^\circ\text{C}$ $V_R = 1200\text{ V}, T_J = 175\text{ }^\circ\text{C}$	Fig. 2
Q_C	Total Capacitive Charge	126		nC	$V_R = 800\text{ V}, I_F = 20\text{ A},$ $T_J = 25\text{ }^\circ\text{C}$	Fig. 6
C	Total Capacitance	1702 120 95		pF	$V_R = 0\text{ V}, T_J = 25\text{ }^\circ\text{C}, f = 1\text{ MHz}$ $V_R = 400\text{ V}, T_J = 25\text{ }^\circ\text{C}, f = 1\text{ MHz}$ $V_R = 800\text{ V}, T_J = 25\text{ }^\circ\text{C}, f = 1\text{ MHz}$	Fig. 5
E_C	Capacitance Stored Energy	32.5		μJ	$V_R = 800\text{ V}$	Fig. 7

Note: This is a majority carrier diode, so there is no reverse recovery charge.

Thermal Characteristics

Symbol	Parameter	Min.	Typ.	Max.	Unit	Note
$R_{\theta JC}$	Thermal Resistance from Junction to Case		0.45		$^\circ\text{C/W}$	Fig.8

Typical Performance

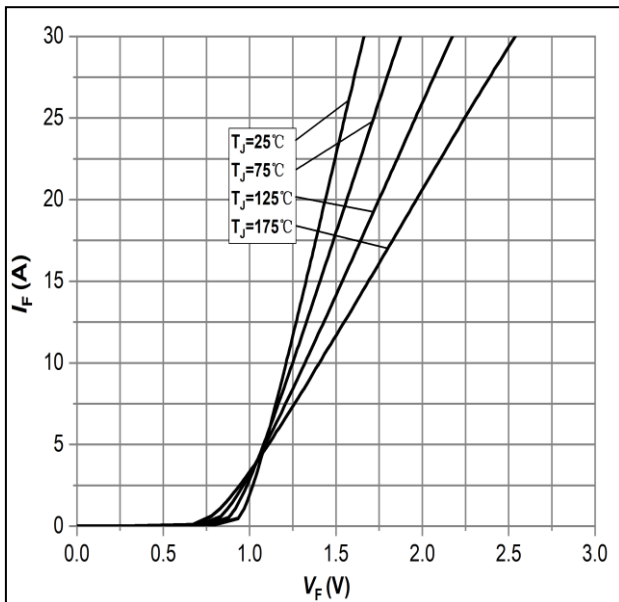

Figure 1: Forward Characteristics

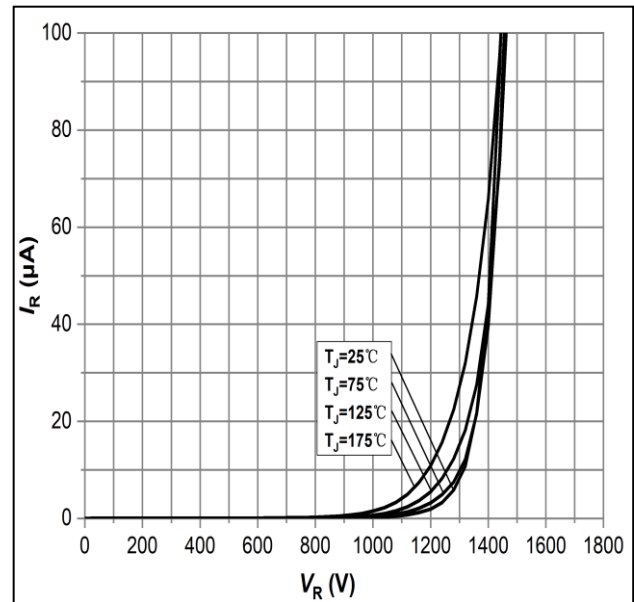

Figure 2: Reverse Characteristics

Typical Performance

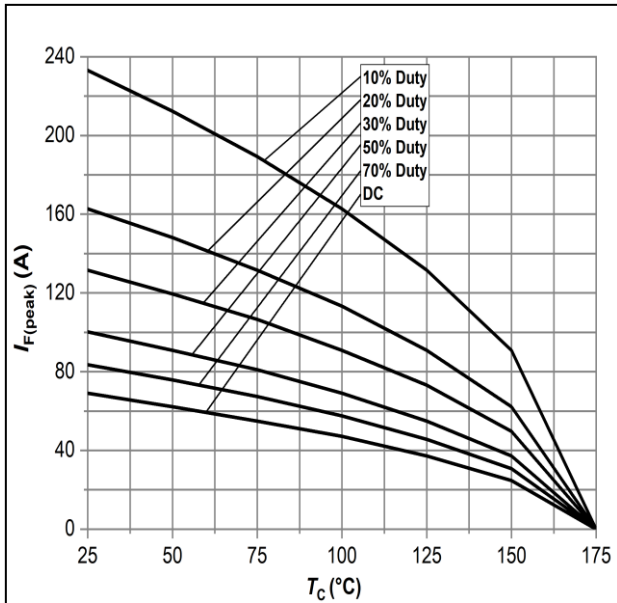

Figure 3: Current Derating

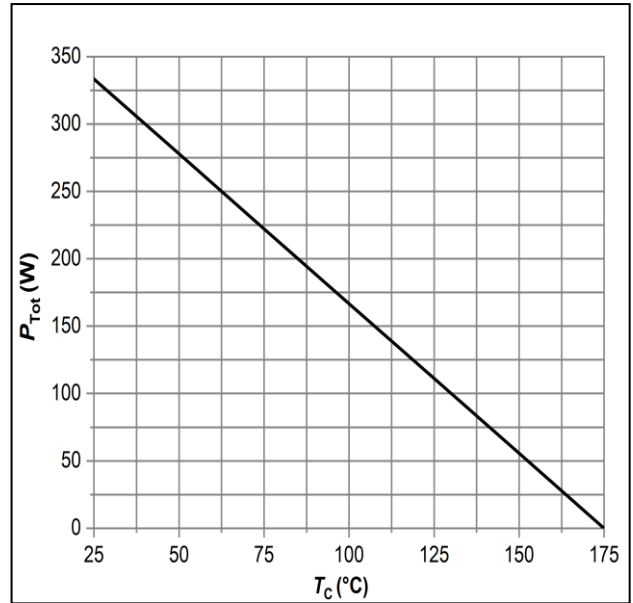

Figure 4: Power Derating

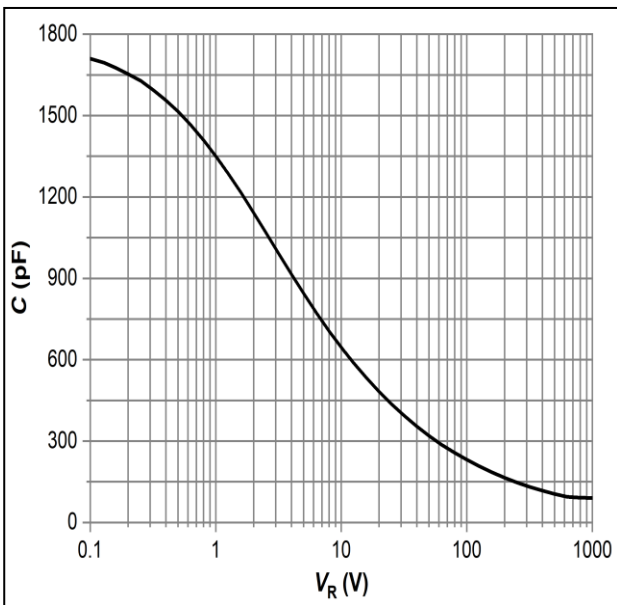

Figure 5: Capacitance vs. Reverse Voltage

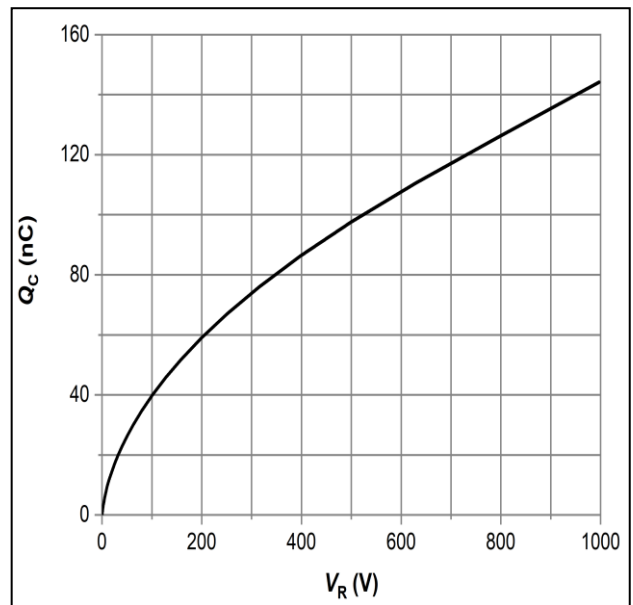

Figure 6: Total Capacitance Charge vs. Reverse Voltage

Typical Performance

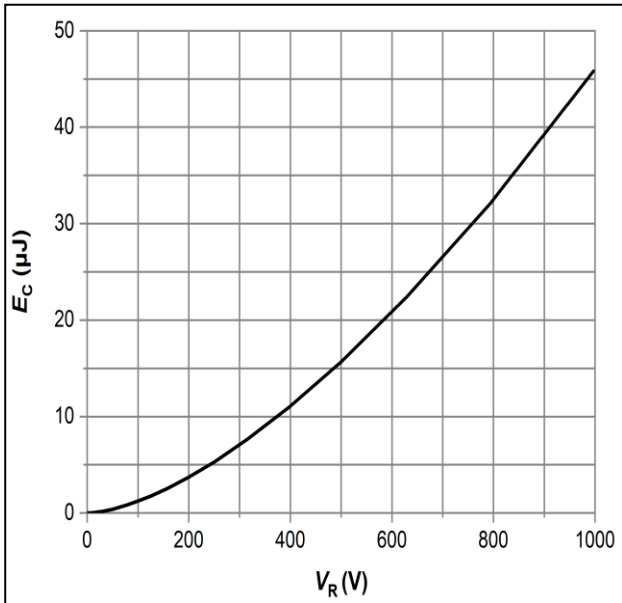

Figure 7: Typical Capacitance Stored Energy

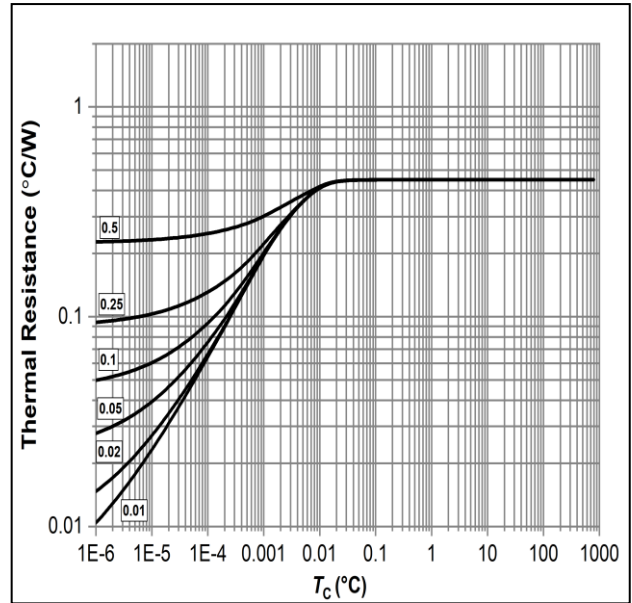
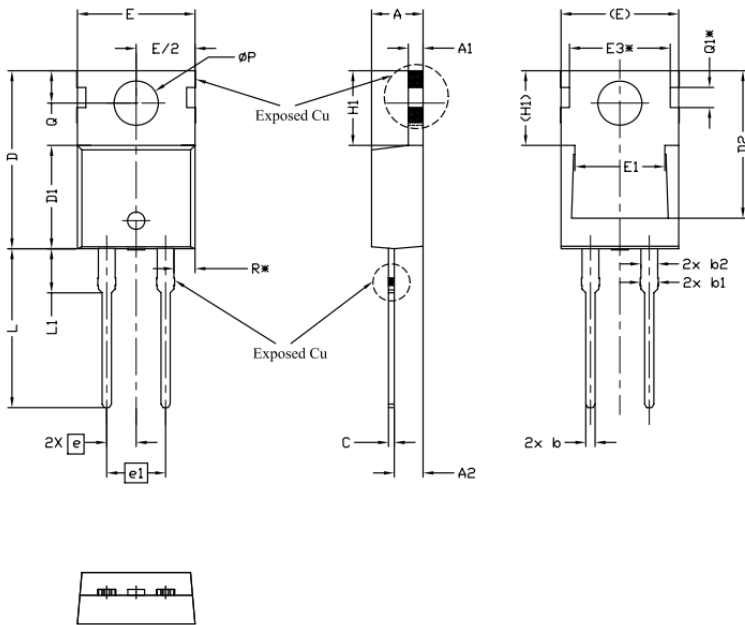

Figure 8: Transient Thermal Impedance

Package Dimensions

Package: TO-220-2



SYMBOL	DIMENSIONS			NOTES
	Min.	NOM	Max.	
A	4.24	4.44	4.64	
A1	1.15	1.27	1.40	
A2	2.30	2.48	2.70	
b	0.70	0.80	0.90	
b1	1.20	1.55	1.75	
b2	1.20	1.45	1.70	
c	0.40	0.50	0.60	
D	14.70	15.37	16.00	4
D1	8.82	8.92	9.02	
D2	12.43	12.73	12.83	5
E	9.96	10.16	10.36	4.5
E1	6.86	7.77	8.89	5
E3*	8.70 REF			
e	2.54 BSC			
e1	5.08 BSC			
H1	6.30	6.45	6.60	5.6
L	13.47	13.72	13.97	
L1	3.60	3.80	4.00	
ϕP	3.75	3.84	3.93	
Q	2.60	2.80	3.00	
Q1*	1.73 REF			
R*	1.82 REF			

NOTE : Dimension L, M, W apply for Solder Dip Finish

Revision History

Document Version	Date of Release	Description of Changes
Rev.1.0	2021.12.9	Released
Rev.1.1	2022.6.18	Characteristic Updated